



ELECTRIC POWER RATINGS GUIDE

GENERATOR SETS

CONTENTS

RATINGS GUIDE

Cat® Diesel Generator Sets	
50 Hz Ratings	4
50 Hz Ratings – Power Plants	6
50 Hz Ratings – Dual Fuel – Power Plants	7
60 Hz Ratings	8
60 Hz Ratings – Dual Fuel – Power Plants	12
50 Hz and 60 Hz – Rental Power Ratings	13
Diesel Rating Definitions	14
Notes	15
Cat Gas Generator Sets	
50 Hz Ratings – Continuous	18
50 Hz and 60 Hz Ratings – Standby	19
50 Hz and 60 Hz – Rental Power Ratings	21
60 Hz Ratings – Continuous	22
Gas Rating Definitions	23
Renewable Energy Products	
Microgrids	26
Notes	29
Home and Outdoor Power Products	
Gasoline	32
Notes	33
EMCP 4	36
Systems Products	40
Reference	46
Product Support – Definitions	53
Product Support – Customer Support Agreements	54
Notes	55





CAT GENERATOR SETS

DIESEL

DIESEL

50 Hz

CAT 50 Hz DIESEL RATINGS, 6.8 – 250 kVA

kVA		Generator Set Model	Engine	Configuration
Standby	Prime			
Single Phase Output* 1500 rpm				
7.5	6.8	DE7.5E3S	C1.1	EU Stage IIIA
11	10	DE11E3S	C1.5	EU Stage IIIA
14	13	DE14E3S	C2.2	EU Stage IIIA
16.5	15	DE16E3S	C2.2	EU Stage IIIA
26	24	DE26E0S	C3.3	Low BSFC
26	24	DE26E3S	C3.3	EU Stage IIIA
40	36	DE40E0S	C3.3	Low BSFC
40	36	DE40E2S	C3.3	EU Stage II
50	45	DE50E0S	C3.3	Low BSFC
55	50	DE55E3S	C4.4	EU Stage IIIA
90	82	DE90E2S	C4.4	EU Stage II
90	82	DE90E3S	C4.4	EU Stage IIIA
Three Phase Output** 1500 rpm				
9.5	8.5	DE9.5E3	C1.1	EU Stage IIIA
13.5	12.5	DE13.5E3	C1.5	EU Stage IIIA
16	14.5	DE16E0	C1.5	Low BSFC
18	16.5	DE18E3	C2.2	EU Stage IIIA
22	20	DE22E3	C2.2	EU Stage IIIA
33	30	DE33E0	C3.3	Low BSFC
33	30	DE33E3	C3.3	EU Stage IIIA
50	45	DE50E0	C3.3	Low BSFC
50	45	DE50E2	C3.3	EU Stage II
55	50	DE55E0	C3.3	Low BSFC
55	50	DE55E2	C4.4	EU Stage II
65	60	DE65E0	C3.3	Low BSFC
65	60	DE65E3	C4.4	EU Stage IIIA
88	80	DE88E0	C4.4	Low BSFC
88	80	DE88E3	C4.4	EU Stage IIIA
110	100	DE110E2	C4.4	EU Stage II
110	100	DE110E3	C4.4	EU Stage IIIA
150	135	DE150E0	C7.1	Low BSFC
165	150	DE165E0	C7.1	Low BSFC
165	150	DE165E3	C7.1	EU Stage IIIA
175	160	DE175E3	C7.1	EU Stage IIIA
200	180	DE200E0	C7.1	Low BSFC
200	180	DE200E3	C7.1	EU Stage IIIA
218	200	DE220E0	C7.1	Low BSFC
250	230	DE250E0	C9	Low BSFC

*All ratings at 1.0 pf. **All ratings at 0.8 pf.

DIESEL

50 Hz

CAT 50 Hz DIESEL RATINGS, 250 – 715 kVA

kVA		Generator Set Model	Engine	Configuration
Standby	Prime			
1500 rpm				
275	250	DE275E0	C9	Low BSFC
300	275	DE300E0	C9	Low BSFC
300	275	DE300E3	C9	EU Stage IIIA
330	300	DE330E0	C9	Low BSFC
—	365	DE365C3	C13	China Non-Road Stage III
—	400	DE400C3	C13	China Non-Road Stage III
400	350	DE400E0	C13	Low BSFC
450	400	DE450E0	C13	Low BSFC
450	400	DE450E3	C13	EU Stage IIIA
450	400	—	C15*	Low BSFC
—	455	DE455C3	C15	China Non-Road Stage III
—	500	DE500C3	C15	China Non-Road Stage III
500	455	DE500E0	C15**	Low BSFC
550	500	DE550E0	C15**	Low BSFC
550	500	DE550E3	C15	EU Stage IIIA
605	550	DE605E0	C18**	Low BSFC
—	600	DE600C3	C18	China Non-Road Stage III
660	600	DE660E0	C18**	Low BSFC
700	635	—	C18*	Low BSFC
715	650	DE715E0	C18**	Low BSFC

*Available in Brazil only. **Nomenclature in Brazil by Engine name only.

CAT 50 Hz DIESEL RATINGS, 680 – 4000 kVA

kVA				Generator Set Model	Configuration
Standby	Mission Critical	Prime	Continuous		
1500 rpm					
750	—	680	—	3412C	Low BSFC
800	—	725	—	3412C	Low BSFC
900	—	810	—	3412C	Low BSFC
1100	1100	1000	910	C32	Low BSFC, Low Emissions
1250	1250	1100	—	C32	Low BSFC
1250	1250	1150	1000	3512	Low BSFC
1400	1400	1275	—	C32	Low BSFC
1400	1400	1275	1206	3512	Low BSFC
1500	1500	1375	—	C32	Low BSFC
1500	1500	1360	—	3512B	Low BSFC, Low Emissions
1600	1600	1500	1320	3512B	Low BSFC, Low Emissions
1750	1750	1600	—	3512B	Low BSFC, Low Emissions
1875	1875	1700	1500	3512B	Low BSFC, Low Emissions
2000	2000	1825	1600	3516	Low BSFC
2250	2250	2000	—	3516C	Low Emissions
2250	2250	2000	1750	3516B	Low BSFC, Low Emissions
2500	2500	2275	—	3516C	Low Emissions
2500	2500	2275	2000	3516B	Low BSFC, Low Emissions

DIESEL

50 Hz

CAT 50 Hz DIESEL RATINGS, 680 – 4000 kVA

kVA				Generator Set Model	Configuration
Standby	Mission Critical	Prime	Continuous		
1500 rpm					
2750	2750	2500	—	3516C	Low BSFC , Low Emissions
3000	3000	2750	—	3516C	EPA Tier 2
3000	3000	2725	—	3516E	Low Emissions
3000	3000	2750	—	3516E	Low BSFC
3000	3000	2750	2500	C175-16	Low BSFC, Low Emissions
3125	3125	2800	—	3516C	EPA Tier 2
3500	3000	3125	—	3516E	EPA Tier 2
3900	3900	3500	3150	C175-20	Low BSFC, Low Emissions
4000*	4000*	3600*	3250*	C175-20	Low BSFC, Low Emissions

*Rating does not include package mounted radiator.

50 Hz – POWER PLANTS

CAT 50 Hz DIESEL RATINGS, 1175 – 7150 kVA

kVA			Generator Set Model	Configuration
Standby	Prime	Continuous		
1000 rpm				
2688	2425	2200	3606	Low BSFC
3575	3250	2938	3608	Low BSFC
—	3250	2938	C280-08	IMO/U.S. EPA Tier 2
5375	4850	4400	3612	Low BSFC
—	4850	4400	C280-12	IMO/EPA Tier 2
7150	6500	5875	3616	Low BSFC
—	6500	5875	C280-16	IMO/EPA Tier 2
750 rpm				
2163	1963	1775	3606	Low BSFC
2863	2600	2363	3608	Low BSFC
4325	3925	3550	3612	Low BSFC
5725	5200	4725	3616	Low BSFC

DIESEL / DUAL FUEL

50 Hz – POWER PLANTS

CAT 50 Hz DIESEL RATINGS, 1094 – 14664 kW_e

kWe*	Model
1000 rpm	
1094	6CM20C
1459	8CM20C
1642	9CM20C
750 rpm	
1728	6CM25C
2304	8CM25C
2592	9CM25C
1930	6CM25E
2573	8CM25E
2895	9CM25E
600 rpm	
2765	6CM32C
3686	8CM32C
4147	9CM32C
750 rpm	
3025	6CM32E
4032	8CM32E
4536	9CM32E
5850	12CM32C
7800	16CM32C
500 rpm	
5238	6CM46DF
5471	6CM43C
6111	7CM46DF
6383	7CM43C
6984	8CM46DF
7294	8CM43C
7857	9CM46DF
8206	9CM43C
10530	12CM46DF
10998	12CM43C
14040	16CM46DF
14664	16CM43C

*All ratings at 0.8 pf.

DIESEL

60 Hz

CAT 60 Hz DIESEL RATINGS, 8 – 600 ekW

ekW		Generator Set Model	Engine	Configuration
Standby	Prime			
Single Phase Output 1800 rpm				
8.8	8	DE7.5E3S	C1.1	EU Stage IIIa
13	12	DE11E3S	C1.5	EU Stage IIIa
17	15.5	DE14E3S	C2.2	EU Stage IIIa
19.4	17.6	DE16E3S	C2.2	EU Stage IIIa
45	40	DE40E0S	C3.3	Low BSFC
60	55	DE50E0S	C3.3	Low BSFC
99.5	90	DE90E2S	C4.4	EU Stage II
Three Phase Output 1800 rpm				
8.8	8	DE9.5E3	C1.1	EU Stage IIIa
13.2	12	DE13.5E3	C1.5	EU Stage IIIa
17.6	16	DE18E3	C2.2	EU Stage IIIa
20	18	DE22E3	C2.2	EU Stage IIIa
30	27	DE33E0	C3.3	Low BSFC
45	40	DE50E0	C3.3	Low BSFC
50	45	DE55E0	C3.3	Low BSFC
60	55	DE65E0	C3.3	Low BSFC
80	72	DE88E0	C4.4	Low BSFC
100	90.4	DE110E2	C4.4	EU Stage II
132	120	DE150E0	C7.1	Low BSFC
150	135	DE165E0	C7.1	Low BSFC
175	160	DE200E0	C7.1	Low BSFC
200	180	DE200SE0	C9	Low BSFC
250	225	DE250SE0	C9	Low BSFC
275	250	DE275SE0	C9	Low BSFC
300	270	DE300SE0	C9	Low BSFC
300	275	DE300SE3	C9	EU Stage II
350	320	DE350SE0	C13	Low BSFC
400	350	DE400SE0	C13	Low BSFC
450	410	DE450SE0	C15	Low BSFC
500	455	DE500SE0	C15	Low BSFC
550	500	DE550SE0	C18	Low BSFC
600	545	DE600SE0	C18	Low BSFC

DIESEL

60 Hz

CAT 60 Hz DIESEL RATINGS, 8 – 200 kW

Available only for North America

kW		Generator Set Model	Engine	Configuration
Standby	Prime			
Single Phase Output* 1800 rpm				
8.8	8	DE7.5E3S	C1.1	ESE
13	12	DE11E3S	C1.5	ESE
17	15.5	DE14E3S	C2.2	ESE
19.4	17.6	DE16E3S	C2.2	ESE
40	36	D40S	C4.4	ESE
50	45	D50S	C4.4	ESE
60	55	D60S	C4.4	ESE
80	72	D80S	C4.4	ESE
100	90	D100S	C4.4	ESE
Three Phase Output** 1800 rpm				
8.8	8	DE9.5E3	C1.1	ESE
13.2	12	DE13.5E3	C1.5	ESE
17.6	16	DE18E3	C2.2	ESE
20	18	DE22E3	C2.2	ESE
40	36	D40	C4.4	ESE
50	45	D50	C4.4	ESE
60	55	D60	C4.4	ESE
80	72	D80	C4.4	ESE
100	90	D100	C4.4	ESE
125	114	D125	C7.1	ESE
150	136	D150	C7.1	ESE
175	158	D175	C7.1	ESE
200	—	D200	C7.1	ESE

*All ratings at 1.0 pf.

**All ratings at 0.8 pf.

ESE = "EPA Stationary Emergency".

DIESEL

60 Hz

CAT 60 Hz DIESEL RATINGS, 180 – 4000 ekW

ekW				Generator Set Model	Configuration
Standby	Mission Critical	Prime	Continuous		
1800 rpm					
200	—	180	—	C9	ESE
250	—	225	—	C9	ESE
300	—	275	—	C9	ESE
350	—	320	—	C13	ESE
400	—	350	—	C13	ESE
450	—	410	—	C15	ESE
500	—	455	—	C15	ESE
500	—	455	—	C18	EPA Tier 4 Final
550	—	500	—	C18	ESE
600	—	545	—	C18	ESE
650	—	591	—	3412C	Low BSFC
700	—	635	—	3412C	Low BSFC
750	—	680	—	C27	ESE, Low BSFC
750	—	680	—	3412C	Low BSFC
800	—	725	—	C27	ESE, Low BSFC
800	—	725	—	3412C	Low BSFC
1000	1000	910	830	C32	ESE, Low BSFC
1100	1100	1000	890	3512	Low BSFC
1100	1100	1000	—	C32	ESE, Low BSFC
1250	1250	1135	—	C32	ESE, Low BSFC
1250	1250	1135	1010	3512	Low BSFC
1400	1400	1275	—	3512B	Low BSFC, Low Emissions
1500	1500	1360	1230	3512B	Low BSFC, Low Emissions
1500	1500	1360	1230	3512C	ESE
1750	1750	1600	—	3512C	ESE
1750	1750	1600	1450	3516	Low BSFC
2000	2000	1825	1640	3516B	Low BSFC, Low Emissions
2000	2000	1825	1650	3516C	EPA Tier 4 Final, ESE
2250	2250	—	—	3516B	Low BSFC
2500	2500	2250	2050	3516C	EPA Tier 4 Final, ESE, Low BSFC
2750	—	2500	—	3516E	ESE
3000	3000	2725	2500	C175-16	EPA Tier 4 Final, ESE, Low BSFC
3900	3900	3500	3150	C175-20	ESE, Low BSFC
4000*	4000*	3600*	3250*	C175-20	ESE, Low BSFC

ESE = "EPA Stationary Emergency".

*Rating does not include package mounted radiator.

DIESEL

60 Hz – POWER PLANTS

CAT 60 Hz DIESEL RATINGS, 1375 – 5320 ekW

ekW			Generator Set Model	Configuration
Standby	Prime	Continuous		
900 rpm				
2000	1820	1650	3606	Low BSFC
2660	2420	2200	3608	Low BSFC
—	2420	2200	C280-08	EPA Tier 4 Final
4000	3640	3300	3612	Low BSFC
—	3640	3300	C280-12	EPA Tier 4 Final
5320	4840	4400	3616	Low BSFC
—	4840	4400	C280-16	EPA Tier 4 Final
720 rpm				
1680	1525	1375	3606	Low BSFC
2200	2020	1830	3608	Low BSFC
3360	3050	2750	3612	Low BSFC
4400	4040	3660	3616	Low BSFC

DIESEL / DUAL FUEL

60 Hz – POWER PLANTS

CAT 60 Hz DIESEL RATINGS, 979 – 14664 kWe

kWe*	Model
900 rpm	
979	6CM20C
1306	8CM20C
1469	9CM20C
720 rpm	
1728	6CM25C
2304	8CM25C
2592	9CM25C
1930	6CM25E
2573	8CM25E
2895	9CM25E
600 rpm	
2765	6CM32C
3686	8CM32C
4147	9CM32C
720 rpm	
3025	6CM32E
4032	8CM32E
4536	9CM32E
5850	12CM32C
7800	16CM32C
514 rpm	
5238	6CM46DF
5471	6CM43C
6111	7CM46DF
6383	7CM43C
6984	8CM46DF
7294	8CM43C
7857	9CM46DF
8206	9CM43C
10530	12CM46DF
10998	12CM43C
14040	16CM46DF
14664	16CM43C

*All ratings at 0.8 pf.

DIESEL

50 Hz AND 60 Hz – RENTAL POWER RATINGS

CAT 50 Hz RENTAL POWER RATINGS, 150 – 2000 kVA

kVA			Generator Set Model	Configuration
Standby	Prime	Continuous		
1500 rpm				
110	100	—	XQP100	EU Stage IIIA and BSFC
165	150	—	XQP150	EU Stage IIIA and BSFC
300	275	—	XQP275	EU Stage IIIA
330	300	—	XQP300	BSFC
550	500	—	XQP500	EU Stage IIIA and BSFC
—	—	1438	XQC1200	Low BSFC/Low Emissions
—	—	1893	XQC1600	Low BSFC/Low Emissions
—	2000	1750	XQ2000 DGB™	Low BSFC

CAT 60 Hz RENTAL POWER RATINGS, kW AND kVA

kW			Generator Set Model	Configuration
Standby	Prime	Continuous		
1800 rpm				
*200	182	—	XQ200	EPA Tier 4 Interim
*500	455	—	XQ500	EPA Tier 4 Interim
*795	725	—	XQ800	EPA Tier 4 Interim
—	—	1260	XQC1200	Low BSFC/Low Emissions
—	—	1705	XQC1600	Low BSFC/Low Emissions
kVA			Generator Set Model	Configuration
Standby	Prime	Continuous		
1800 rpm				
38	34	—	XQ35	EPA Tier 4 Final
—	59	—	XQ60	EPA Tier 4 Final
138	125	—	XQ125	EPA Tier 4 Final
469	425	—	XQ425	EPA Tier 4 Final
625	568	—	XQ570	EPA Tier 4 Final

*Subject to availability "Flex".

DIESEL

RATINGS DEFINITIONS

CAT DIESEL RATING DEFINITIONS

Standby Power

Output available with varying load for the duration of the interruption of the normal source power. Average power output is 70% of the standby power rating. Typical operation is 200 hours per year, with maximum expected usage of 500 hours per year.

Mission Critical

Output available with varying load for the duration of the interruption of the normal source power. Average power output is 85% of the mission critical power rating. Typical peak demand up to 100% of rated power for up to 5% of the operating time. Typical operation is 200 hours per year, with maximum expected usage of 500 hours per year.

Prime Power

Output available with varying load for an unlimited time. Average power output is 70% of the prime power rating. Typical peak demand of 100% of prime-rated kW with 10% of overload capability for emergency use for a maximum of 1 hour in 12. Overload operation cannot exceed 25 hours per year.

Continuous Power

Output available without varying load for an unlimited time. Average power output is 70 – 100% of the continuous power rating. Typical peak demand is 100% of continuous rated kW for 100% of operating hours.

NOTES

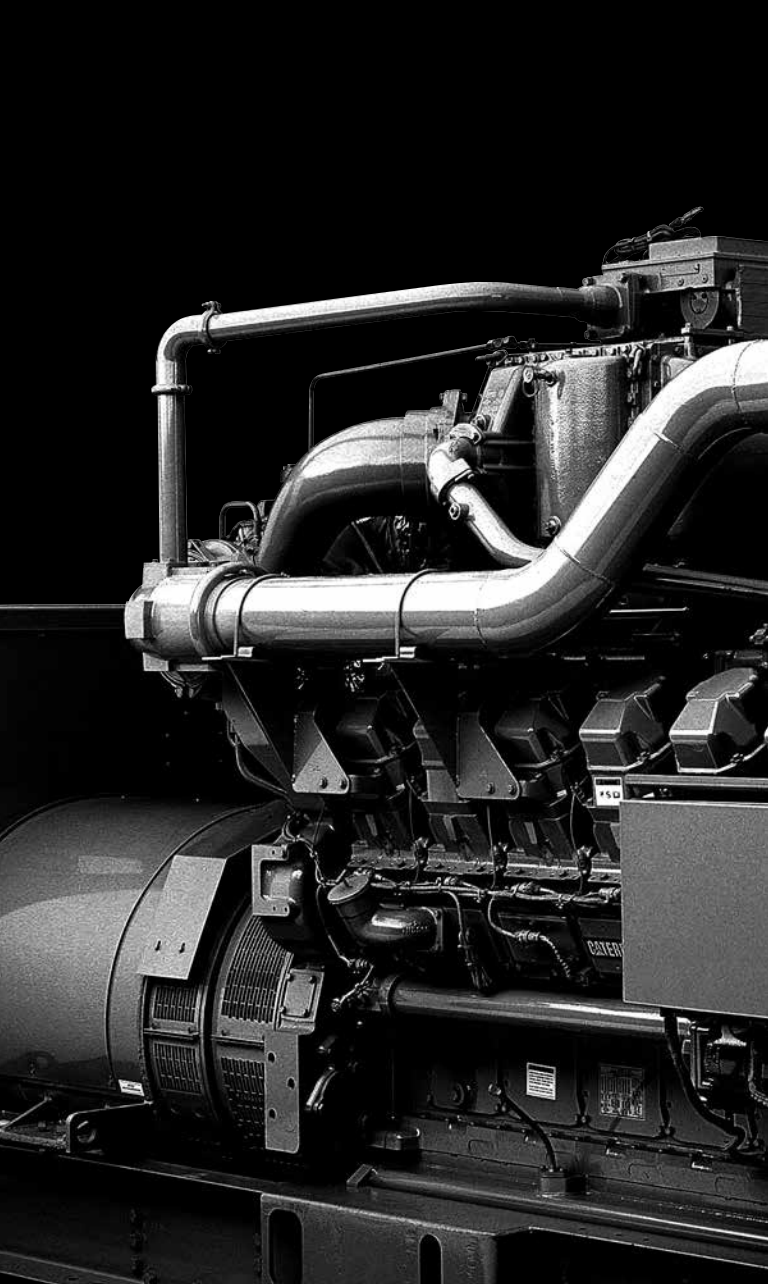

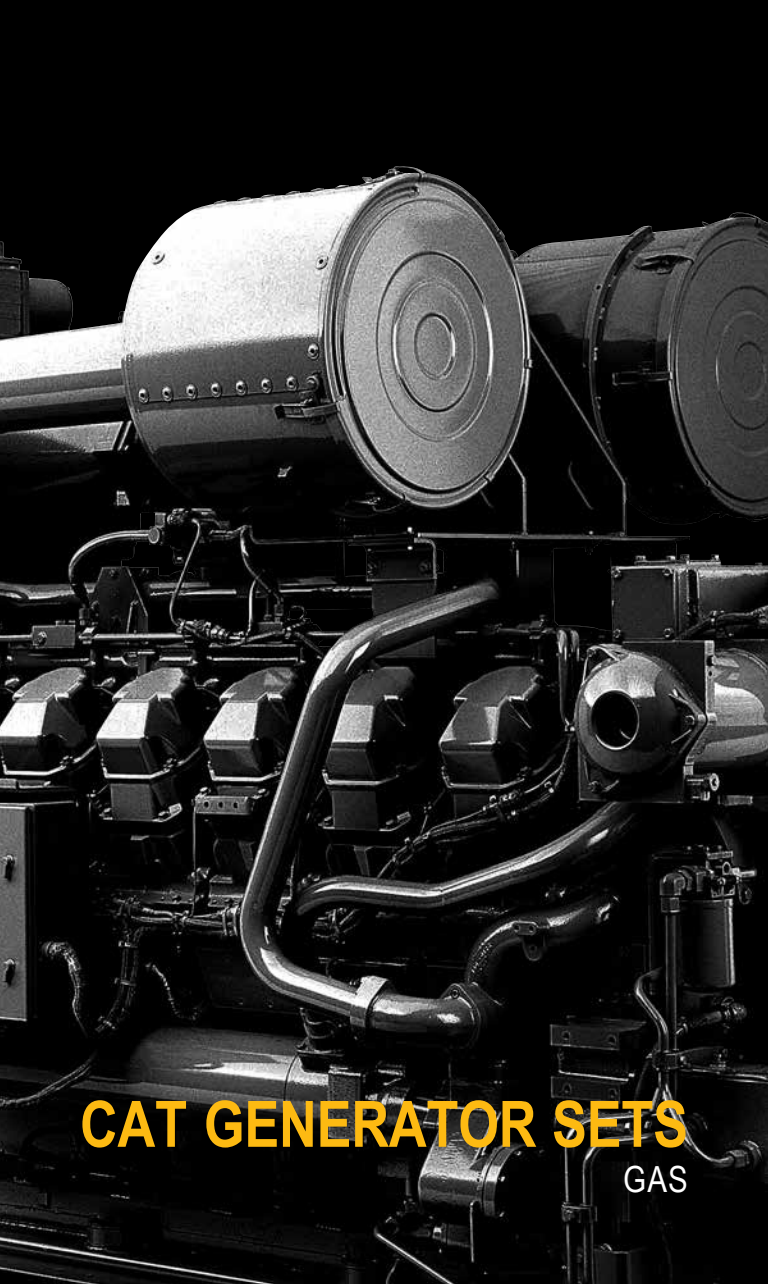

CAT GENERATOR SETS

GAS

GAS

50 Hz – CONTINUOUS

CAT 50 Hz CONTINUOUS – GAS RATINGS, 68 – 14040 ekW

eKW	Natural Gas	Biogas
1500 rpm		
68	—	G3306
86	G3306	—
107	—	G3406
115	G3306	—
126	G3406	—
166	G3406	—
174	—	G3412
374	G3412C	—
400	CG132-8	CG132-8
600	CG132-12	CG132-12
800	CG132-16	CG132-16
983	G3516	—
1000	CG170-12	CG170-12
1016	G3512E	—
1041	—	G3516A
1088	G3516B	—
1105	—	G3516A+
1125	CG170-12	—
1200	CG170-12	CG170-12
1211	G3512E	—
1500	CG170-16	—
1560	CG170-16	CG170-16
1603	G3516E	—
1603	G3516C	—
1976	G3520C	—
1984	—	G3520C
2000	CG170-20	CG170-20
2010	G3520C	—
2022	G3516H	—
2039	G3520E	—
2519	G3520H	—
1000 rpm		
3333	CG260-12	—
3770	—	CG260-16
4300	CG260-16	—
4500	CG260-16	—
750 rpm*		
6552	G16CM34 ¹⁾	—
9750	G20CM34 ¹⁾	—

*All ratings at 0.8 pf. DF: Dual Fuel.

¹⁾Further gas qualities on request.

GAS

50 Hz AND 60 Hz – STANDBY

CAT 50 Hz CONTINUOUS – GAS RATINGS, 68 – 14040 eKW

eKW	Natural Gas	Biogas
500 rpm*		
5238	6CM46DF	—
6111	7CM46DF	—
6984	8CM46DF	—
7857	9CM46DF	—
10530	12CM46DF	—
14040	16CM46DF	—

*All ratings at 0.8 pf. DF: Dual Fuel.

CAT 60 Hz NATURAL GAS RATINGS, 30 – 150 eKW

Available only for North America

eKW Standby	Generator Set	Engine	Configuration
	Model		
Single Phase Output 1800 rpm			
30	DG30-2	3.0	ESE
30	DG30-4	3.0	SCAQMD
50	DG50-2	5.7	ESE
50	DG50-4	5.7	SCAQMD
60	DG60-2	5.7	ESE
60	DG60-4	5.7	SCAQMD
80	DG80-2	5.7	ESE
100	DG100-2	5.7	ESE
Three Phase Output* 1800 rpm			
30	DG30-2	3.0	ESE
30	DG30-4	3.0	SCAQMD
50	DG50-2	5.7	ESE
50	DG50-4	5.7	SCAQMD
60	DG60-2	5.7	ESE
60	DG60-4	5.7	SCAQMD
80	DG80-2	5.7	ESE
100	DG100-2	5.7	ESE
125	DG125-2	8.8	ESE
150	DG150-2	8.8	ESE

*All ratings at 0.8 pf.

ESE = "EPA Stationary Emergency".

SCAQMD = "South Coast Air Quality Management District".

GAS

60 Hz – STANDBY

CAT 60 Hz PROPANE GAS RATINGS, 30 – 140 ekW

Available only for North America

ekW	Generator Set	Engine	Configuration
Standby	Model		
Single Phase Output* 1800 rpm			
30	DG30-2	3.0	ESE
30	DG30-4	3.0	SCAQMD
50	DG50-2	5.7	ESE
50	DG50-4	5.7	SCAQMD
60	DG60-2	5.7	ESE
60	DG60-4	5.7	SCAQMD
90	DG100-2	5.7	ESE
Three Phase Output** 1800 rpm			
30	DG30-2	3.0	ESE
30	DG30-4	3.0	SCAQMD
50	DG50-2	5.7	ESE
50	DG50-4	5.7	SCAQMD
60	DG60-2	5.7	ESE
60	DG60-4	5.7	SCAQMD
92	DG100-2	5.7	ESE
140	DG150-2	8.8	ESE

*All ratings at 1.0 pf.

**All ratings at 0.8 pf.

ESE = "EPA Stationary Emergency".

SCAQMD = "South Coast Air Quality Management District".

GAS

60 Hz – STANDBY

50 Hz AND 60 Hz – RENTAL POWER RATINGS

CAT 60 Hz STANDBY – GAS RATINGS, 150 – 1500 ekW

ekW	Natural Gas
1800 rpm*	
150	G3406
230	G3406
350	G3412
423	G3412C
500	G3412C
750	G3512
1000	G3512
1500	G3516C

*All ratings at 0.8 pf.

CAT 60 Hz GAS RENTAL POWER RATINGS, 135 – 400 ekW

ekW	Generator Set	Configuration
Continuous	Model	
1800 rpm		
135	XG135	Factory certified US EPA Nonroad and Stationary SI Engine
400	XG400	Factory certified US EPA Nonroad SI Engine

CAT 50 – 60 Hz GAS RENTAL POWER RATINGS, 1475 ekW

ekW	Generator Set	Configuration
Continuous	Model	
1500 – 1800 rpm		
1475	XQ1475	US EPA NSPS SI Capable

GAS

60 Hz – CONTINUOUS

CAT 60 Hz CONTINUOUS – GAS RATINGS, 76 – 14040 ekW

ekW	Natural Gas	Biogas
1800 rpm		
76	—	G3306
104	G3306	—
137	—	G3406
143	G3306	—
155	G3406	—
194	—	G3412
217	G3406	—
253	G3412	—
400	CG132-8	CG132-8
403	G3412	—
453	G3412C	—
600	CG132-12	CG132-12
800	CG132-16	CG132-16
1663	G3516C	—
2077	G3520C	—
1500 rpm		
1125	CG170-12	—
1200	CG170-12	CG170-12
1500	CG170-16	—
1560	CG170-16	CG170-16
1936	—	G3520C
2000	CG170-20	CG170-20
2008	G3516H	—
2026	G3520E	—
2500	G3520H	—
1200 rpm		
615	—	G3512
779	G3516	—
824	—	G3516A
1015	—	G3516A+
1312	G3516B	—
1626	G3520C	G3520C
900 rpm		
3000	CG260-12	—
3370	—	CG260-16
4000	CG260-16	—
4050	CG260-16	—

CAT 60 Hz CONTINUOUS – GAS RATINGS, 76 – 14040 ekW

ekW	Natural Gas	Biogas
720 rpm*		
6552	G16CM34 ¹⁾	—
9750	G20CM34 ¹⁾	—
514 rpm*		
5238	6CM46DF	—
6111	7CM46DF	—
6984	8CM46DF	—
7857	9CM46DF	—
10530	12CM46DF	—
14040	16CM46DF	—

*All ratings at 0.8 pf.

¹⁾Further gas qualities on request. DF: Dual Fuel

CAT GAS RATING DEFINITIONS

Standby Power Rating

Output available with varying load for the duration of an emergency outage. Average power output is 100% of the standby power rating. Typical operation is 200 hours per year, with maximum expected usage of 500 hours per year.

Continuous Power Rating

Output available with non-varying load for an unlimited time. Average power output is 70-100% of the continuous power rating. Typical peak demand is 100% of continuous rated ekW for 100% of operating hours.





CAT RENEWABLE ENERGY PRODUCTS

RENEWABLE ENERGY

PHOTOVOLTAIC

Cat Photovoltaic (PV) Module

Model	Power Output	Type
PVT115	115 watt per panel	Thin Film

Inverter Options – UL Listed

Output	Voltage	Frequency
30 kW	480V, 3 Phase	60 Hz
24 kW	480V, 3 Phase	60 Hz
12 kW	480V, 3 Phase	60 Hz
7.7 kW	208/240V, 1 Phase	60 Hz
7 kW	208/240V, 1 Phase	60 Hz
6 kW	208/240V, 1 Phase	60 Hz
5 kW	208/240V, 1 Phase	60 Hz
3.8 kW	208/240V, 1 Phase	60 Hz
3 kW	208/240V, 1 Phase	60 Hz

Inverter Options – CE Mark

Output	Voltage	Frequency
25 kW	380V – 415V, 3 Phase	50 – 60 Hz
20 kW	380V – 415V, 3 Phase	50 – 60 Hz
15 kW	380V – 415V, 3 Phase	50 – 60 Hz
12 kW	380V – 415V, 3 Phase	50 – 60 Hz
10 kW	380V – 415V, 3 Phase	50 – 60 Hz
8 kW	380V – 415V, 3 Phase	50 – 60 Hz
7 kW	380V – 415V, 3 Phase	50 – 60 Hz
5 kW	220 – 240V, 1 Phase	50 – 60 Hz
4 kW	220 – 240V, 1 Phase	50 – 60 Hz
3.6 kW	220 – 240V, 1 Phase	50 – 60 Hz
3 kW	220 – 240V, 1 Phase	50 – 60 Hz

Inverter Options – Domestic China

Output	Voltage	Frequency
40 kW	380V – 400V	50 Hz
33 kW	380V – 400V	50 Hz
20 kW	380V – 400V	50 Hz

RENEWABLE ENERGY

ENERGY STORAGE

ENERGY STORAGE SYSTEMS

Grid Stability Modules

Grid Stability modules provide a pre-engineered solution to energy storage needs. The modules integrate with diesel or gas generator sets, photovoltaic (PV), or other renewable systems to provide short duration power. The module holds closely regulated system voltage and frequency during periods of rapid load addition or removal, or during periods of intermittent output from the renewables.

Model	20 Second Output	30 Minute Output
PGS250	—	250 kW
PGS500	—	500 kW
PGS1000	—	1000 kW
PGS1500	—	1500 kW
PGS250 U	250 kW	—
PGS500 BU	500 kW	250 kW
PGS1000 BU	1000 kW	500 kW
PGS1500 BU	1500 kW	750 kW

Energy Time Shift Module

Energy Time Shift modules provide a pre-engineered solution to energy storage needs. The scalable system integrates with photovoltaic (PV) or other renewable systems to store energy from renewables, generator sets, or the grid for use at a later time.

Model	Rated Power	Discharge Time
ES287H250	250 kW	1 hour
ES1.0H250 MW	250 kW	4 hour
ES1.8H250 MW	250 kW	7.2 hour
ES2.3H250 MW	250 kW	10 hour
ES1.2H1.0 MW	1000 kW	1 hour

RENEWABLE ENERGY

CONTROLS

CAT MICROGRID MASTER CONTROLLER (MMC)

MMC-S

The MMC-S is designed for residential and small business installations. It integrates the photovoltaic (PV) system, generator set, and energy storage system to provide renewable capacity penetration up to 60%.

MMC-M

The MMC-M is designed for industrial and small community installation. It integrates with the photovoltaic (PV) system, generator set, and energy storage system to provide renewable capacity penetration of greater than 60%. The MMC-M provide black start capability and performs load mangement functions.

MMC-L

The MMC-L is designed for large industrial, campus, and distributed resource installations. It integrates with the photovoltaic (PV) system, generator set, and energy storage system to provide renewable capacity penetration of greater than 60%. The MMC-L can control distributed assets and provides black start capability and load management functions.

NOTES





RP4400 CAT

**HOME AND OUTDOOR
POWER PRODUCTS**

GASOLINE

60 Hz AND 50 Hz

60 Hz 3600 rpm

USA and Canada

Model	Engine cc	Running Watts	Starting Watts	Output Volts
RP3600	212 OHV	3600	4500	120
RP5500	300 OHV	5500	6875	120 / 240
RP6500E	420 OHV	6500	8125	120 / 240
RP7500E	420 OHV	7500	9375	120 / 240
RP12000E	670 OHV Twin	12000	15000	120 / 240

EPA, CARB and CSA compliant models are available.
All ratings are Single Phase at 1.0 pf.

50 Hz 3000 rpm

UK and EU*

Model	Engine cc	Rated Watts (Prime)	Maximum Watts (Standby)	Output volts
RP2500	212 OHV	2300	2500	115 / 230
RP3100	212 OHV	2800	3100	115 / 230
RP4400	300 OHV	4000	4400	115 / 230

All models are CE compliant.

*EU models are 230 volt only.

All ratings are Single Phase at 1.0 pf.

Further information available at: cat.com/portablepower

NOTES

CAT

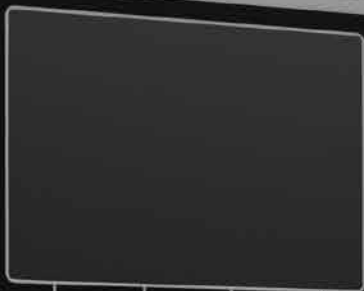

EMCP 4.4



CAT

EMERGENCY STOP



OVERHEAT



HIGH COOLANT TEMPERATURE



LOW COOLANT TEMPERATURE



LOW OIL PRESSURE



OVERFUEL



LOW COOLANT LEVEL



SWITCHES LEAK



CONTROL SWITCH NOT IN AUTO



HIGH BATTERY VOLTAGE



LOW BATTERY VOLTAGE



LOW CHARGING VOLTAGE



BATT CHARGER NOT WORKING



EXCESSIVE LIGHT



ENGINE OVERHEATING SYSTEM FAILURE



HYDRAULIC SYSTEM FAILURE



HYDRAULIC SYSTEM FAILURE



794-0001

EMCP 4



EMCP 4

CAT EMCP 4

EMCP 4.1

The EMCP 4.1 provides basic engine controls – stop/run/auto push button controls, cycle crank, and cool down timer. The 3.8 inch graphical display supports multiple languages, including character languages such as Chinese, Arabic, Russian, and Japanese. The EMCP 4.1 provides monitoring of generator electrical output, including AC voltage, current, and frequency, and mechanical information such as oil pressure, coolant temperature, engine speed, and battery voltage along with fuel level if a sensor is provided. It also provides a number of protective functions, such as warnings and shutdowns for over/under voltage, over/under frequency, low oil pressure, high coolant temperature, low coolant level, failure to start, and overspeed.

EMCP 4.2

The EMCP 4.2 builds on the features of the EMCP 4.1 controller, offering expanded engine monitoring based on information available from the engine ECM, along with expanded generator set protection and monitoring, such as generator kW, kVA, and kWh.

Flexibility is also increased with the addition of a modbus RTU communication port, remote annunciator modules, and expansion I/O modules to allow the EMCP 4 system to be configured to meet site specific design requirements.

With the additional monitoring and expansion modules available, the EMCP 4.2 is designed to provide control and protection for critical installations, such as NFPA-110 Level 1 applications.

EMCP 4.2B

The EMCP 4.2B adds some advanced features to the EMCP 4.2 controller, offering expanded generator set protection and monitoring, such as additional overcurrent protection curve selection, real (kW) load histogram, trip kWh and trip kVAh. Display screens are configurable for customer desired parameters.

An integrated basic programmable logic control (PLC) function to read controller inputs and drive controller outputs is also provided with the EMCP 4.2B.

EMCP 4.3

The EMCP 4.3 further expands the EMCP 4 product line with the addition of 5.5 inch graphical display and additional context specific navigation keys.

With the addition of a modbus TCP port, the EMCP 4.3 controller can be easily integrated into complex systems requiring complete generator set monitoring.

EMCP 4.4

The EMCP 4.4 builds on the EMCP 4.3 functionality with the addition of fully automatic multi generator set paralleling. The EMCP 4.4 provides all of the functions required to automatically parallel generator sets, including dead bus arbitration, automatic or manual modes of operation, and load sharing (real and reactive).





CAT

SYSTEMS PRODUCTS

SYSTEMS PRODUCTS

CAT PARALLELING PRODUCTS

Description	EMCP 4.4	EMCP4.4 + System Master
	On Package Gen to Gen Paralleling	Gen Group to Utility Paralleling with System Master HMI
Operating Modes		
Emergency Standby/Island Mode	X	X
Utility Paralleling		X
System Capacity		
Number of Units	≤8	≤8
Voltages		
Low Voltage (≤ 600 V)	X	X
Medium Voltage (601-27 kV)		
Generator Paralleling Functions		
Dead Bus Arbitration	X	X
Synchronization	X	X
Load Sharing	X	X
Load Shed/Add	X	X
Load Sense/Load Demand	X	X
Utility Paralleling Functions		
Load Management/Peak Shaving		X
Utility Transfer Control		X
Utility Protective Relay		

SYSTEMS PRODUCTS

EXL	EPIC	EGIS	Custom Switchgear
Single Generator to Utility Paralleling with Optional Switchgear	Modular Control Panels Ideal for Adding Additional Generation Capacity	Modular Configurable Controls and Switchgear with Standardized Sequence of Operations	Design to Order Switchgear with Customizable Sequence of Operations
X	X	X	X
X	X	X	X
1	≤12	≤12	Unlimited
X	X	X	X
X	X		X
X	X	X	X
X	X	X	X
X	X	X	X
X	X	X	X
X	X	X	X
X	X	X	X
X	X	X	X

SYSTEMS PRODUCTS

ATS

Amp Rating	Poles	Model	Type
40-4000	2,3,4	MX	Contactactor
40-1600	2,3,4	ATC	Contactactor
30-1000	2,3,4	ATC	MCCB & MCS
200-5000	2,3,4	ATC	Power Breaker

Operating Modes:

- Open Transition
- Closed Transition
- Delayed Transition
- Bypass Isolation

UPS BYPASS SWITCHES

UPS kVA	Max Continuous Amps	Max AIC	Configuration	Operation	UPS Bypass Mode Interlock	Model
300-600	800	65k	Wall Mount	Manual	Solenoid Kirk-Keys	9088
300-1200	1600	65k	Free Standing	Manual	Solenoid Kirk-Keys	9082
300-1200	1600	65k	Free Standing	Manually Initiated Automatic	Electronic	UBP

Listed to UL891

Fixed Mount

Consult Dealer for Parallel Applications

SYSTEMS PRODUCTS

UPS 50 Hz

Output kVA	Parallel Capable	UPS Model	UPS Type	Energy Storage
250	N	UPS250i	Line Interactive	Flywheel
250-500	Y	UPS500iG	Line Interactive	Flywheel
625	Y	UPS750	Line Interactive	Flywheel
250-1000	Y	UPS1000iZ	Line Interactive	Flywheel

60 Hz

Output	Parallel Capable	UPS Model	UPS Type	Energy Storage
300	N	UPS300	Line Interactive	Flywheel
300-600	Y	UPS600G	Line Interactive	Flywheel
750	Y	UPS750	Line Interactive	Flywheel
300-1200	Y	UPS1200Z	Line Interactive	Flywheel

CAT DATA CENTER ADVANTAGES



**40% TCO
Savings**



**12x Less
Likely to Fail**



**9x Less Carbon
Emissions**



CAT

WARNING

CATERPILLAR

LOW OIL PRESSURE

EMERGENCY STOP

OVER CURRENT STOP

ENGINE PROTECTIVE

OVERCHARGE

SPARE 1

SPARE 2

SPARE 3

FAULT PROTECTION

FAULT ALARM

POWER METER

AC METER

ENGINE METER

LAMP TEST

ALARM CODES

EXIT

SERVICE MENU



REFERENCE GUIDE

REFERENCE

FUEL SYSTEM – DIESEL

Day Tank Sizing

$$\text{Tank Size (gal)} = \frac{\text{Rated BSFC (lb/hp}\cdot\text{hr)}}{7.076 \text{ (lb/gal)}} \times \text{Rated HP} \times \text{Load Factor}$$

x Hours Between Refilling
+ Reserve Requirement

OR

Rule of Thumb for tank size with 25% reserve

$$0.056 \times \text{Ave. BHP demand} \times \text{Hours between refills} \times 1.25 = \text{_____ gal.}$$

$$0.27 \times \text{Ave. BKW demand} \times \text{Hours between refills} \times 1.25 = \text{_____ liters.}$$

Note: Additional tank capacity required for cooling of recirculated fuel in unit-injected engines. Tank should be located below level of injectors or nozzles.

On-Site Power Requirements

Based on 100,000 sq ft. of office bldg., etc and 40°N. Latitudes

- Electric Requirements
 - 600 kW continuous load
 - (Air conditioning is absorption)
 - Use three – 300 kW units
 - (2 prime and 1 standby)
- Air Conditioning and Compressor
 - 400 tons prime load
 - Use two – 200 hp engines
 - (No Standby)

Refrigeration

- One ton refrigeration = 200 Btu/min = 12,000 Btu/h
- One Boiler hp = 33,475 Btu/h
- One ton compressor rating = One engine hp
- Auxiliary air conditioning equipment requires 1/4 hp/ton of compressor rating

Ice Plant

- Complete power requires 4-5 hp per daily ton capacity

Air Compressor

- hp = 1/4 x cu ft m/min at 100 psi
- Increase bhp 10% for 125 psi
- Decrease bhp 10% for 80 psi

REFERENCE

ELECTRICAL TABLES

To Obtain	Alternating Current		Direct Current
	Single-Phase	Three-Phase	
kW	$\frac{V \times I \times P.F.}{1000}$	$\frac{1.732 \times V \times I \times P.F.}{1000}$	$\frac{V \times I}{1000}$
kVA	$\frac{V \times I}{1000}$	$\frac{1.732 \times V \times I}{1000}$	
Horsepower required when kW known (Generator)	$\frac{kW}{.746 \times \text{EFF. (Gen)}}$	$\frac{kW}{.746 \times \text{EFF. (Gen)}}$	$\frac{kW}{.746 \times \text{EFF. (Gen)}}$
kW input when HP known (Motor)	$\frac{HP \times .746}{\text{EFF. (Mot.)}}$	$\frac{HP \times .746}{\text{EFF. (Mot.)}}$	$\frac{HP \times .746}{\text{EFF. (Mot.)}}$
Amperes when HP known	$\frac{HP \times .746}{V \times P.F. \times \text{EFF.}}$	$\frac{HP \times .746}{1.732 \times V \times \text{EFF.} \times P.F.}$	$\frac{HP \times .746}{V \times \text{EFF.}}$
Amperes when kW known	$\frac{kW \times 1000}{V \times P.F.}$	$\frac{kW \times 1000}{1.732 \times V \times P.F.}$	$\frac{kW \times 1000}{V}$
Amperes when kVA known	$\frac{kVA \times 1000}{V}$	$\frac{kVA \times 1000}{1.732 \times V}$	
Frequency Hz	$\frac{\text{Poles} \times \text{RPM}}{120}$	$\frac{\text{Poles} \times \text{RPM}}{120}$	
Reactive kVA (kVAr)	$\frac{V \times I \times \sqrt{1-(P.F.)^2}}{1000}$	$\frac{1.732 \times V \times I \times \sqrt{1-(P.F.)^2}}{1000}$	
% Voltage Regulation	$\frac{100 (V_{NL}-V_{FL})}{V_{FL}}$	$\frac{100 (V_{NL}-V_{FL})}{V_{FL}}$	$\frac{100 (V_{NL}-V_{FL})}{V_{FL}}$

ELECTRICAL TABLE ABBREVIATIONS:

V – voltage in volts
I – current in amperes
kW – power in kilowatts (actual power)
kVA – kilovolt-amperes (apparent power)
HP – horsepower
RPM – revolutions per minute

kVAr – reactive kilovolt-amperes
EFF. – efficiency as a decimal factor
NL – no load
FL – full load
P.F. – power factor
 Note: DC kW = DC kVA

REFERENCE

THREE-PHASE CONNECTION SYSTEMS

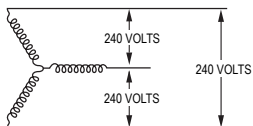

THREE-PHASE, THREE-WIRE (WYE)

A

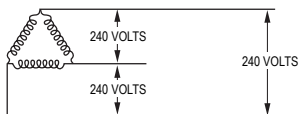

THREE-PHASE, THREE-WIRE (DELTA)

B

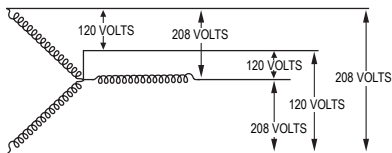

THREE-PHASE, FOUR-WIRE (WYE)

C

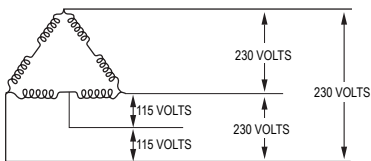

THREE-PHASE, FOUR-WIRE (DELTA)

D

REFERENCE

REDUCED VOLTAGE STARTERS

Type of Starter	Motor Voltage (% Line Voltage)	Line Current (% Full Voltage) Starting Current	Starting Torque (% of Full Voltage) Starting Torque
Full Voltage Starter	100	100	100
Auto Transformer			
• 80% Tap	80	68	64
• 65% Tap	65	46	42
• 50% Tap	50	30	25
Resistor Starter Single Step (adjusted for motor voltage to be 80% of line voltage)	80	80	64
Reactor			
• 50% Tap	50	50	25
• 45% Tap	45	45	20
• 37.5% Tap	37.5	37.5	14
Part Winding (low- speed motors only)			
• 75% Winding	100	75	75
• 80% Winding	100	50	50

REFERENCE

COMPARISON OF REDUCED VOLTAGE STARTING METHODS

Characteristic	Autotransformer	Primary Resistor	Reactor	Two-Step Part Winding
Starting Line Current at Same Motor Terminal Voltage	Least	— More than autotransformer type —		
Starting Power Factor	Low	High*	Low	Low
Power Draw from Line During Starting	Low	— More than autotransformer type —		
Torque	Increased slightly with speed	Increases rapidly with speed		Increases slightly with speed
Smoothness of Acceleration	Motor momentarily disconnected from line from start to run	Smooth. Transfer made with little change in motor terminal voltage		Smooth
Relative Cost	Average	Lower in small size – otherwise equal	Average	Less than others
Ease of Control	Same	Same	Same	No provision for adjustment of starting current
Maintenance	Same	Same	Same	Less than others
Line Disturbance	— Varies with conditions and type of load —			More than others

*Resistor starting adds considerable kW load to generator set. Total power required includes the motor kW and the kW which is lost as heat in the resistor. The series resistors account for a higher than normal starting power factor.

REFERENCE

ENGINE ROOM VENTILATION

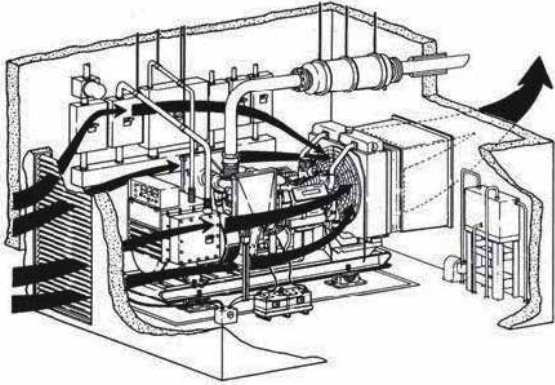

Engine room ventilation can be estimated by the following formulas, assuming 100° F (38° C) ambient air temperature:

$$V \text{ (cfm)} = \frac{H}{0.070 \times 0.24 \times \Delta T} + \text{Engine Combustion Air}$$

$$V \text{ (m}^3\text{/min)} = \frac{H}{1.099 \times 0.017 \times \Delta T} + \text{Engine Combustion Air}$$

V = Ventilation air (cfm) (m³/min).

H = Heat radiation (Btu/min) (kW).

ΔT = Permissible temperature rise in engine room (°F) (°C).

Density of air at 100° F = 0.070 lb/cu ft (1.099 kg/m³).

Specific heat of air = 0.24 Btu/°F (0.017 kW/°C).

REFERENCE

CONVERSION FACTORS

Temperature Conversion

$$^{\circ}\text{F} = (1.8 \times ^{\circ}\text{C}) + 32$$

$$^{\circ}\text{C} = 0.5555 (^{\circ}\text{F} - 32)$$

Angle

$$1 \text{ quadrant} = 90 \text{ degrees}$$

$$1 \text{ quadrant} = 1.57 \text{ radians}$$

$$1 \text{ radian} = 57.3 \text{ degrees}$$

$$1 \text{ degree} = 60 \text{ minutes}$$

$$1 \text{ minute} = 2.9 \times 10 \text{ radians}$$

Identifying Code Letters on AC Motors	
NEMA Code Letter	Starting skVA/hp
A	0.00 – 3.14
B	3.15 – 3.54
C	3.55 – 3.99
D	4.00 – 4.49
E	4.50 – 4.99
F	5.00 – 5.59
G	5.60 – 6.29
H	6.30 – 7.09
J	7.10 – 7.99
K	8.00 – 8.99
L	9.00 – 9.99
M	10.00 – 11.19
N	11.20 – 12.49
P	12.50 – 13.99
R	14.00 – 15.99
S	16.00 – 17.99
T	18.00 – 19.99
U	20.00 – 22.39
V	22.40

Note: Code letters apply to motors up to 200 HP.

PRODUCT SUPPORT

PRODUCT SUPPORT DEFINITIONS

Extended Service Coverage (ESC)

Depending on the model and application, Silver, Gold, Platinum and Platinum Plus coverage levels are available from Caterpillar with terms to meet most applications, whether prime or standby.

Platinum and Platinum Plus provide additional allowances for overtime, emergency freight, rental, crane and rigging support. Please see the registration contract for details.

Equipment	Coverage Option
New Product	New ESC
Existing Product	Advantage ESC
Overhauls	OPC*

Electric Power ESC reimburses covered parts at customer list price, labor at selling rates and travel and mileage charges (less any deductibles) for covered repairs.

Available worldwide for all Cat Electric Power Products, ESC provides usual and customary parts and labor costs for covered system failures due to defects in materials and workmanship on components over the duration of the covered period.

This is a brief description of Extended Coverage. See your Cat dealer for more information. The Extended Coverage contract will govern.

*Overhaul Protection Coverage

PRODUCT SUPPORT

CUSTOMER SUPPORT AGREEMENTS

- A **Customer Support Agreement (CSA)** is an arrangement between the end user and the Cat dealer that helps lower the cost per unit of production.
- Agreements are tailored to fit your business needs and can range from simple Preventive Maintenance Kits to sophisticated Total Cost Performance Guarantees.
- Qualified Factory Trained dealer technicians assist you by maintaining your Cat Electric Power Products and driving down operating costs. Perhaps the most important feature of any CSA is flexibility.
- A **Preventive Maintenance (PM)** agreement covers specified maintenance at a fixed cost. You maintain reliability and efficiency because the maintenance is performed by highly skilled technicians at guaranteed costs, giving you the ability to budget more accurately.
- A **Total Maintenance and Repair (TM&R)** agreement covers all of the maintenance and repair costs. Instead of paying for maintenance or repairs as they are needed, you pay one flat rate to cover a broad range of parts and services.

	PM	TM&R
Detailed inspections by highly skilled technicians	✓	✓
Scheduled maintenance	✓	✓
Labor and travel costs	✓	✓
Use of genuine Cat parts, fluids and filters	✓	✓
S·O·S SM Services and interpretation	✓	✓
Component repairs		✓
All unscheduled repairs, including wear out, with no exclusions, limitations or deductibles		✓

Check with your local Cat dealer for available options with each agreement.

NOTES

NOTES

For additional information or to find
your nearest dealer go to:

www.cat.com/powergeneration

LEXE7582-07 February 2017

© 2017 Caterpillar All Rights Reserved Printed in
USA CAT, CATERPILLAR, their respective logos,
"Caterpillar Yellow" the "Power Edge" trade dress, as
well as corporate and product identity used herein,
are trademarks of Caterpillar and may not be used
without permission.

BUILT FOR IT.™